

CE980

USB True 4K DisplayPort/HDMI Optical KVM Extender (True 4K @ 300 m)



Unleash 300 m Optical KVM Extension with True 4K

4K TRUE

DP/HDMI Combo Connector

CE980 True 4K USB DisplayPort/HDMI Optical KVM Extender

The CE980 is a USB DisplayPort/HDMI Optical KVM Extender that extends KVM signals over fiber-optic transmission up to 300 meters, delivering True 4K, HDCP 2.3-compliant video quality. It features DisplayPort and HDMI connectivity via a combo connector, simplifying installation with selectable video output at both local and remote consoles. In addition to exceptional video clarity, it supports RS-232, USB 2.0 peripherals, and embedded DisplayPort/HDMI digital audio, including Dolby TrueHD, Dolby Digital Plus, and DTS-HD Master Audio, enabling versatile signal extension over a single fiber optic connection. The CE980 is ideal for critical control environments such as healthcare, post production, manufacturing, and more.

**4K
TRUE**

HDR



Fiber Optic
Transmission



DP/HDMI
Combo Connector



Dual Console with
Privileged Control

2-in-1 DisplayPort/HDMI Combo Connector

Featuring a combo connector, the CE980 supports connection to either a DisplayPort or HDMI display for both local and remote KVM installations. This versatile design supports flexible display configurations at each end, allowing mixed or matched output types between the local and remote consoles.





Pristine True 4K Clarity with HDR10

Experience unparalleled True 4K clarity (3840 x 2160 and 4096 x 2160 @60 Hz, 4:4:4) and HDR10 support, delivering optimal image accuracy, enhanced contrast, and rich colors for razor-sharp video content.



Reliable Fiber Optic KVM Extension over Long Distances

Deploying the CE980 enables long-distance KVM extension of up to 300 meters via a fiber optic connection, ensuring stable, interference-free transmission with inherent EMI resistance for reliable performance.

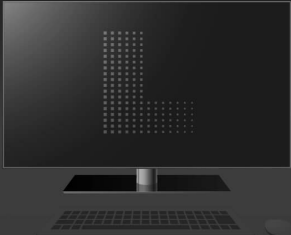
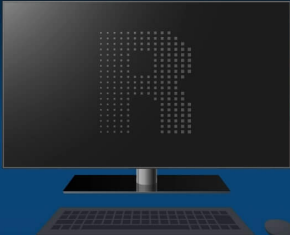
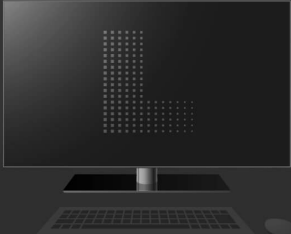

Dual Console Access with Privileged Control

The CE980 enables KVM access to a computer from both local and remote consoles, facilitating efficient operational collaboration. Using the Auto/Local or Auto/Remote pushbutton, you can toggle between Auto mode (access from both consoles) and Local/Remote mode (exclusive access from either local or remote console), determining which console has privileged control over the computer.

<p>Local Console with privilege</p>  <ul style="list-style-type: none"> <input type="radio"/> AUTO <input checked="" type="radio"/> LOCAL <input type="radio"/> REMOTE 	<p>Remote Console</p> <ul style="list-style-type: none"> <input type="radio"/> AUTO <input type="radio"/> REMOTE <input checked="" type="radio"/> LOCKED <p>No Keyboard/ Mouse Access</p> 
<p>Local Console</p>  <ul style="list-style-type: none"> <input type="radio"/> AUTO <input type="radio"/> LOCAL <input checked="" type="radio"/> REMOTE <p>No Keyboard/ Mouse Access</p>	<p>Remote Console with privilege</p> <ul style="list-style-type: none"> <input type="radio"/> AUTO <input checked="" type="radio"/> REMOTE <input type="radio"/> LOCKED 

Applications

Designed for critical control environments such as healthcare, post production, and manufacturing, the CE980 delivers stable long-distance KVM signal transmission and pristine video quality.

- 1.
- 2.
- 3.
- 4.





Media Post Production



Automated Production Line

[Previous](#) [Next](#)

Talk to Our Experts

If you prefer to have ATEN contact you, please complete the form and a representative will be in touch with you shortly

First Name *

Last Name *

- Country *

Company *

Email *

Phone Number *

- Customer Type *

Job Title *

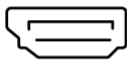

DP/HDMI Connector



Fiber Optic

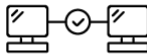

Local/Remote Console

Features

The ATEN CE980 USB True 4K DisplayPort/HDMI Optical KVM Extenders ensure transmission of True 4K video, KVM and control signals over a single fiber optic cable, extending up to 300 m. The CE980 supports HDR10 to deliver unparalleled True 4K video quality (3840 x 2160 @ 60 Hz, 4:4:4 / 4096 x 2160 @ 60 Hz, 4:4:4) with full color accuracy.

Thanks to a built-in DisplayPort / HDMI combo connector, the CE980 allows for either HDMI or DisplayPort connection on both local and remote consoles, with video input and output selectable for flexible installation and mixed / matched display configurations between both ends. The CE980 also extends keyboard / mouse control, RS-232, USB 2.0 data, and both stereo and embedded audio, including LPCM 7.1CH, Dolby TrueHD, Dolby Digital Plus, and DTS-HD Master Audio, over fiber optic cabling. The privilege control function enables easy access management between local and remote consoles through an Auto/Local or Auto/Remote pushbutton, allowing flexible control switching based on operational requirements.

The CE980 is perfect for applications that require high-quality, long-distance KVM operation extension, such as healthcare facilities, post-production, manufacturing, and more.

- DisplayPort/HDMI combo connector supports both DisplayPort and HDMI video interfaces
- Extends DisplayPort/HDMI video, keyboard/mouse control, stereo/embedded audio, RS-232 control, and USB 2.0 signals over fiber optic cabling
- Ultra-long distance transmission up to 300m
- Supports True 4K video up to 4096 x 2160 / 3840 x 2160 @ 60 Hz (4:4:4) with HDCP 2.2/2.3 compliance
- Supports HDR10 for enhanced video quality
- Dual console operation – supports local and remote system control with configurable privilege modes (Auto/Local and Auto/Remote) for streamlined access management and operational efficiency
- USB 2.0 Hub – supports 2 ports for USB KB/MS and 2 ports for other USB peripherals
- Easily switch EDID priority between Local and Remote via hotkey
- Supports wide screen format
- Supports dual independent stereo audio – mic and speaker
- Supports lossless digital audio formats such as LPCM 7.1CH, Dolby TrueHD, Dolby Digital Plus, and DTS-HD Master Audio
- Works with SFP Module [2A-141G](#) (300 m, multi-mode) to offer 10Gbps transmission via a single fiber cable
- [2X-EA17](#) HDMI Lock Pro for combo connector to secure HDMI cables to selected devices and prevent signal loss caused by the connector detaching
- PC wakeup function via a single pushbutton through RS-232 channel
- Plug-and-play operation with no software or driver required
- DC Jack with screw-lock ensures stable and secure connection
- Built-in 8KV/15KV ESD protection
- Rack-mountable
- Firmware upgradeable

Specifications

Function	CE980L	CE980R
Connectors		
Console Ports	4 x USB Type A Female (White) 1 x DisplayPort/HDMI Female (Black) 1 x Mini Stereo Jack Female (Green) 1 x Mini Stereo Jack Female (Pink)	4 x USB Type A Female (White) 1 x DisplayPort/HDMI Female (Black) 1 x Mini Stereo Jack Female (Green) 1 x Mini Stereo Jack Female (Pink)
KVM Ports	1 x USB Type B Female (White) 1 x DisplayPort/HDMI Female (Black) 1 x Mini Stereo Jack Female (Green) 1 x Mini Stereo Jack Female (Pink)	N/A
RS-232	1 x DB-9 Female (Black)	1 x DB-9 Male (Black)
Power	1 x DC Jack (Black)	1 x DC Jack (Black)
Unit To Unit	1 x bi-directional SFP+ (LC)	1 x bi-directional SFP+ (LC)
Video		
Max. Resolution	Up to 4096 x 2160 @ 60Hz (4:4:4) / 3840 x 2160 @ 60Hz (4:4:4)	Up to 4096 x 2160 @ 60Hz (4:4:4) / 3840 x 2160 @ 60Hz (4:4:4)
LEDs		
Video Input	1 (Orange)	N/A
Console Status	3 (Orange)	3 (Orange)
Video Output	N/A	1 (Orange)
Link	1 (Orange)	1 (Orange)
Power	1 (Green)	1 (Green)
Switches		
Operation Mode Selection	1 x Pushbutton	1 x Pushbutton
Wakeup PC	N/A	1 x Pushbutton
Fiber Optics		
Operating Distance	300 m with Multi Mode (MM) fiber (*Note)	300 m with Multi Mode (MM) fiber (*Note)
Data Rate	Single fiber: 10 Gbps	Single fiber: 10 Gbps
Power Consumption	DC12V:11.89W:86BTU/h Note: ● The measurement in Watts indicates the typical power consumption of the device with no external loading. ● The measurement in BTU/h indicates the power consumption of the device when it is fully loaded.	DC12V:9.49W:81BTU/h Note: ● The measurement in Watts indicates the typical power consumption of the device with no external loading. ● The measurement in BTU/h indicates the power consumption of the device when it is fully loaded.
Environmental		
Operating Temperature	0–40°C	0–40°C
Storage Temperature	-20–60°C	-20–60°C
Humidity	0–80% RH, Non-condensing	0–80% RH, Non-condensing
Physical Properties		
Housing	Metal	Metal
Weight	0.85 kg (1.87 lb)	0.84 kg (1.85 lb)
Dimensions (L x W x H)	17.82 x 15.62 x 2.88 cm (7.02 x 6.15 x 1.13 in.)	17.82 x 15.62 x 2.88 cm (7.02 x 6.15 x 1.13 in.)
Note	1. Operating distance is approximate. A typical maximum distance may vary depending on factors such as fiber type, bandwidth, connector splicing, losses, modal or chromatic dispersion, environmental factors, and kinks. 2. It is recommended that you use Multi Mode fibers that conform to IEC 11801 (OM3) specifications. 3. The Device is class 1 laser product. It meet the safety regulations of IEC-60825, FDA 21 CFR 1040.10, and FDA 21 CFR 1040.11.	1. Operating distance is approximate. A typical maximum distance may vary depending on factors such as fiber type, bandwidth, connector splicing, losses, modal or chromatic dispersion, environmental factors, and kinks. 2. It is recommended that you use Multi Mode fibers that conform to IEC 11801 (OM3) specifications. 3. The Device is class 1 laser product. It meet the safety regulations of IEC-60825, FDA 21 CFR 1040.10, and FDA 21 CFR 1040.11.
Note	For some of rack mount products, please note that the standard physical dimensions of WxDxH are expressed using a LxWxH format.	

Diagram

▶ Diagram

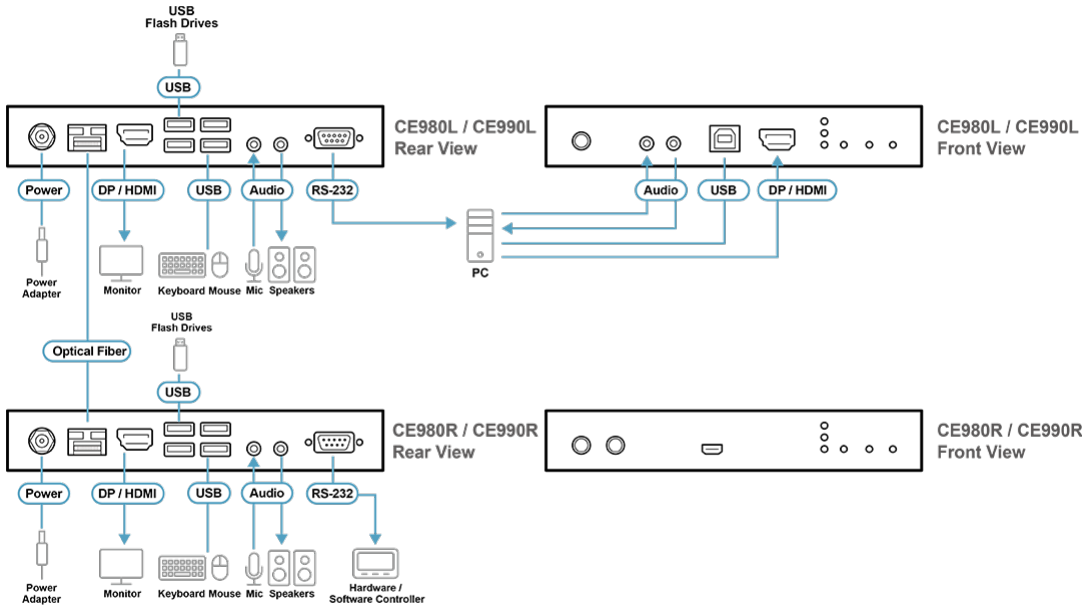

ATEN International Co., Ltd.

3F., No.125, Sec. 2, Datong Rd., Sijhih District., New Taipei City 221, Taiwan
 Phone: 886-2-8692-6789 Fax: 886-2-8692-6767
 www.aten.com E-mail: marketing@aten.com



© Copyright 2015 ATEN® International Co., Ltd.
 ATEN and the ATEN logo are trademarks of ATEN International Co., Ltd.
 All rights reserved. All other trademarks are the property of their respective owners.