

RCM816A

1-Local/8-Remote Shared Access 16-Port Multi-Interface Cat 5 KVM over IP Switch



The RCM Series of KVM over IP switches RCM816A provides local console and remote over IP access for users to monitor and access their entire data center over a network. The RCM series offers superior FHD video resolution up to 1920 x 1200, virtual media transmissions at double speed, FIPS 140-2 with level 1 security standards by using an embedded FIPS 140-2 certified OpenSSL cryptographic module. Equipped with dual on-board NICs, the RCM series is built to ensure reliability and availability of remote access to all servers. The RCM series can be remotely accessed via WinClient / JavaClient* at a console from a separated location for management and operation.

The RCM series is compatible with ATEN's KVM over IP Console Station – the KA82 series. The KA82 series is a standalone console that replaces PC or NB, enabling users to remotely access, monitor and control all servers connected to multiple ATEN's RCM series with impenetrable security against virus threats. It is especially suitable for environments where a PC is not allowed. In addition, the RCM series works with ATEN's PDU remote power management systems from the KVM over IP switches' user interface.

Integrated with ATEN's exclusive RCM API, the RCM series delivers optimal OCR functionality and customizable system integration and automation. Additionally, by using the [RCMMS](#) (RCM Management Software), an intuitive, centralized management platform featuring Panel Array, users can manage, monitor, and control up to hundreds of RCM devices simultaneously.

To ensure seamless connectivity, the RCM series is equipped with dual LAN capability for keeping operation at the production line smooth and efficient.

All in all, the RCM series provides a complete system management across different facilities reduces the number of operators required on site to minimize space requirement while maximizing personnel efficiency. With its over-IP access eliminating the need to physically move legacy KVM solution to each malfunctioning unit, providing users with the ability to capture the device display screen data for data collection and direct OCR analysis, and using APIs for software integration applications, it is an outstanding solution for high-tech production lines requiring durable and reliable over-IP server management.

Note:

We recommend using WinClient app or JavaClient app for more robust management and control. Performance and usage may vary depending on the user's hardware configuration. A minimum of 8GB RAM, dual core CPU and a graphics card that supports OpenGL is required. Please also make sure that the browser is the latest version.



Features

• Exclusive RCM functionalities

- Supports exclusively integrated RCM APIs with various functions, such as OCR, for system integrators
- Supports [RCMMS](#) for customizable Panel Array for operators to monitor all machines simultaneously
- Supports ATEN Access Control Box for on-site enabling / disabling of remote control privilege*
- OSD title bar notification – instantly notifies users upon urgent events*
- Local console priority – gives the local console the priority over remote consoles to access the connected server*
- Supports RS-232 and USB touch panel for easy and intuitive control*

Note: These exclusive RCM functions are supported when working with KVM Adapter Module – [KA7174](#).

• Hardware

- Laptop USB Console (LUC) – a dedicated USB port directly connects to a laptop for easy console operation
- 8 separate buses for remote KVM over IP access
- Two 10 / 100 / 1000 Mbps NICs for redundant LAN or two IP operation
- Blade server support
- Supports PS/2, USB, Sun Legacy and serial (RS-232) connectivity
- Multiplatform server environments: Windows, Mac, Sun, Linux and VT100 based serial devices
- Audio enabled
- Video resolution up to 1920 x 1200 @ 60 Hz; 24-bit color depth

• **Management**

- Integration with ATEN [CCVSR](#) Video Session Recording Software
- Supports 64 user accounts and up to 32 users can be logged in at the same time for control and management
- Green IT Fan – auto-fan-speed adjustment responding to temperature
- Event logging and Windows-based log server
- Event notification – supports notification of SMTP email, SNMP Trap, and SMS (with additional mobile devices)
- Event destination – event logs will be saved to Log server, Syslog server, and USB drive
- Firmware upgradeable
- Out-of-Band access – modem dial-in / dial-out / dial-back support
- Adapter ID – stores port information allowing administrators to relocate the servers to different ports, without having to re-configure the adapters and switches
- Port share mode – allows multiple users to gain access to a server simultaneously
- Supports ATEN KVM over IP console station (KA82xx series)
- Power association enables the switch's KVM ports to be associated with ATEN PDUs power outlets for remote power management
- Supports IPv4, IPv6

• **Easy-to-Use Interface**

- Panel Array Mode™ – monitors all ports in a grid display (both local and remote screens)
- Local console, browser-based, and AP GUIs offer a unified multi-language interface to minimize the user training time and increase productivities
- Multiplatform client support (Windows, Mac OS X, Linux, and Sun)
- Multi-browser support – Internet Explorer, Chrome, Firefox, Safari, Opera, and Netscape
- Browser-based GUI in pure Web technology –allows administrators to perform administrative tasks without preinstalled software. (e.g. Java)
- Supports web-friendly KVM-over-IP access with HTML5 WebClient viewer – users can remotely access all the connected servers and PCs without Java or browser plug-in installation
- Users can launch multiple virtual remote desktop sessions to control multiple servers during the same login
- Full-screen or sizable and scalable virtual remote desktop
- Keyboard / mouse broadcast – keyboard and mouse signals can be duplicated across all servers simultaneously
- Video syncing with the local console – local console monitor's EDID information stored on the KVM adapter for display resolution optimization

• **Security**

- High-grade security – supports FIPS 140-2 level 1 security standards that use an embedded FIPS 140-2 certified OpenSSL cryptographic module (Certificate #1747, #2398, #2473)
- Remote authentication support: RADIUS, LDAP, LDAPS, and MS Active Directory
- Supports TLS 1.2 data encryption and RSA 2048-bit certificates to secure users log in from browser
- Flexible encryption design allows users to choose any combination of 56-bit DES, 168-bit 3DES, 256-bit AES, 128-bit RC4, or random for independent keyboard / mouse, video, and virtual media data encryption
- Support for IP / MAC filter
- Configurable user and group permissions for server access and control
- Automated CSR creation utility and third party CA certificate authentication

• **Virtual Media**

- Virtual media enhances data transmission performance, ideally for file transfers, OS patching, software installations and diagnostic testing
- Works with USB enabled servers in operating system and BIOS level
- Support USB2.0 DVD / CD drives, USB mass storage devices, PC hard drives and ISO images

• **Virtual Remote Desktop**

- Video quality such as monochrome color depth, threshold and noise settings, bandwidth increment / reduction can be adjusted for optimizing data transfer speed
- Mouse DynaSync™ – automatically synchronizes the local and remote mouse movements
- On-screen keyboard with multi-language support
- BIOS-level access for Troubleshooting

Specifications

Console Connections	
Local	1 (Share)
Remote	8
Computer Connections	
Direct	16
Port Selection	Pushbuttons, Hotkeys, GUI
Connectors	
Console Ports	2 x USB Type A Female (White) 1 x HDMI Female (Black) 1 x VGA HDB-15 (Blue)

USB Port	3 x USB Type A Female
Audio	2 x Audio Jack Female
Laptop USB Console (LUC) Port	1 x USB Mini-B Female
KVM Ports	16 x RJ-45 Female
Serial	1 x RJ-45 Female
PON	1 x RJ-45 Female
LAN Ports	2 x RJ-45 Female
Power	1 x IEC 60320/C14
Switches	
Port Selection	2 x Pushbuttons
Reset	1 x Semi-recessed Pushbutton
Power	1 x Rocker Switches
LEDs	
Online / Selected	16 (Green/Orange)
Link 10 / 100 / 1000 Mbps	2 (Red/Orange/Green)
Power	1 (Green)
Emulation	
Keyboard / Mouse	PS/2; USB
Video	
Local	1920 x 1200 @ 60Hz
Remote	1920 x 1200 @ 60Hz
Scan Interval	1 – 255 Sec
Maximum Input Power Rating	100–240V~ ; 50-60Hz; 1A
Power Consumption	AC110V:74W:400BTU/h AC220V:72.8W:395BTU/h Note: ● The measurement in Watts indicates the typical power consumption of the device with no external loading. ● The measurement in BTU/h indicates the power consumption of the device when it is fully loaded.
Environmental	
Operating Temperature	0 - 40°C
Storage Temperature	-20 - 60°C
Humidity	0 - 80% RH, Non-condensing
Physical Properties	
Housing	Metal
Weight	5.20 kg (11.45 lb)
Dimensions (L x W x H)	43.36 x 41.21 x 4.40 cm (17.07 x 16.22 x 1.73 in.)
Note	For some of rack mount products, please note that the standard physical dimensions of WxDxH are expressed using a LxWxH format.

Diagram

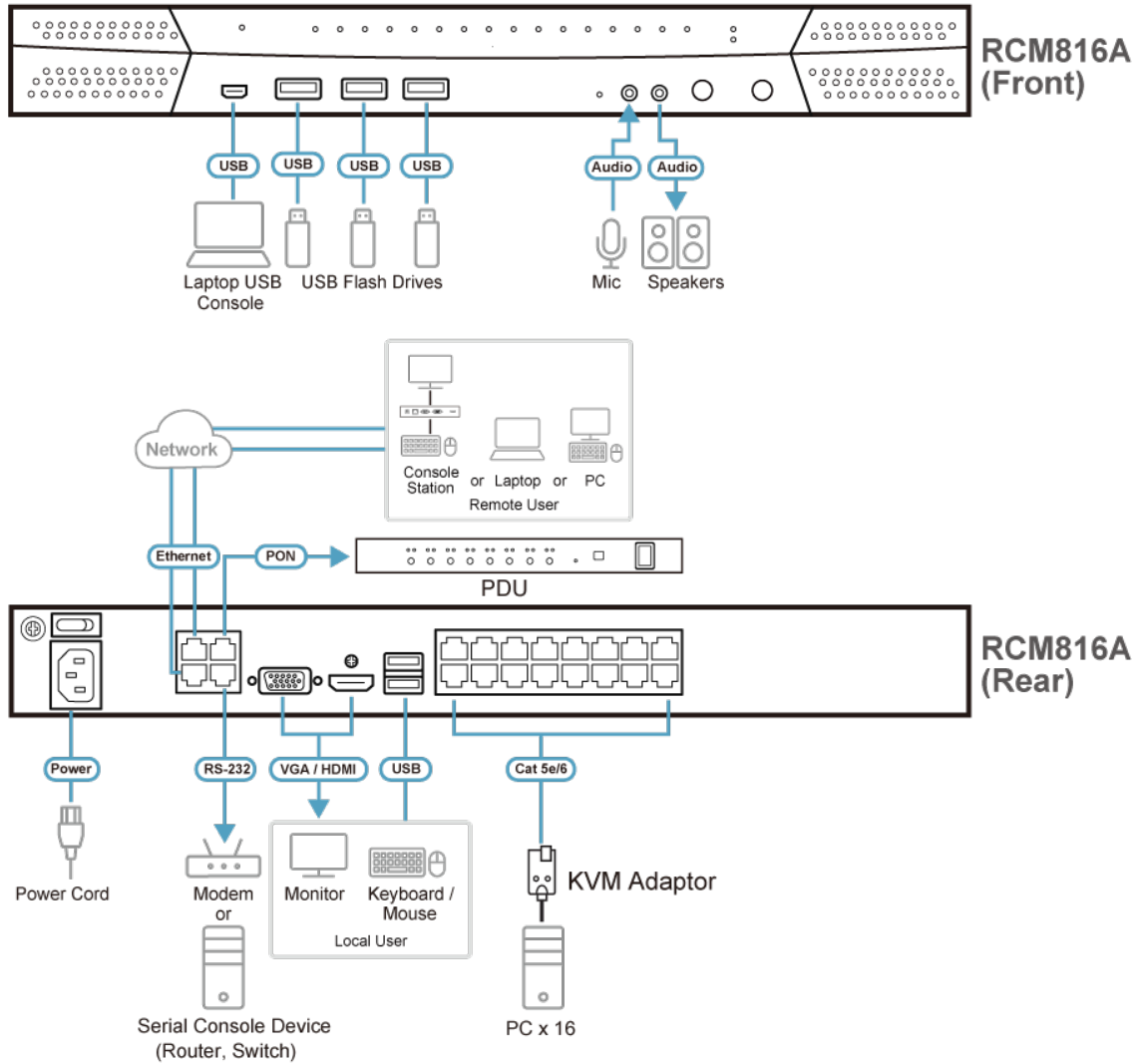

ATEN International Co., Ltd.

3F., No.125, Sec. 2, Datong Rd., Sijhih District., New Taipei City 221, Taiwan
 Phone: 886-2-8692-6789 Fax: 886-2-8692-6767
 www.aten.com E-mail: marketing@aten.com



© Copyright 2015 ATEN® International Co., Ltd.
 ATEN and the ATEN logo are trademarks of ATEN International Co., Ltd.
 All rights reserved. All other trademarks are the property of their respective owners.