

VS194

4-port True 4K DisplayPort Splitter



The VS194 4-Port 4K DisplayPort Splitter is the perfect solution for anyone who needs to send one source of DisplayPort high definition video to 4 DisplayPort displays. The VS194, not only splits but also expands DisplayPort audio/video signals on 4 DisplayPort monitors, is ideal for any multi-display application.

The VS194 is compatible with [DisplayPort 1.2a](#) and can support up to 4K resolution at 60 Hz, making it effective and ideal for use with all DisplayPort displays in corporate, educational, and commercial settings.



Features

- Connects 1 DisplayPort source to 4 DisplayPort monitors
- Supports [DisplayPort 1.2a](#); HDCP 1.3
- Supports resolutions up to 4096 x 2160 / 3840 x 2160 @ 60 Hz
- Supports [MST](#)/ Extend Mode and SST/ Split Mode*

MST/ Extend Mode:

Extend a video source across 4 displays with a maximum resolution of 4K.

SST/ Split Mode:

Duplicate a single video source to 4 displays with a maximum resolution of 4K on each monitor

- Supports Linkrate: HBR2 (High Bit Rate 2)

Note:

* The VS194 will bypass EDID Mode during SST Mode and will detect the resolution of the monitor connected to port 1.

Specifications

Video Output	
Interfaces	4 x DisplayPort Female (Black)
Max. Distance	4.6m (4096 x 2160 / 3840 x 2160 @ 60Hz) *tested with 2L-7D04DP
Video Input	
Interfaces	1 x DisplayPort Female (Black)
Max. Distance	4.6m (4096 x 2160 / 3840 x 2160 @ 60Hz) *tested with 2L-7D04DP
Video	
Compliance	DP 1.2a; HDCP 1.3
Max. Resolution	Up to 4096 x 2160 / 3840 x 2160 @ 60Hz
Max. Data Rate	21.6 Gbps (5.4 Gbps per lane)
Connectors	
Power	1 x DC Jack
Power Consumption	DC5V:3.36W:44BTU/h Note: <ul style="list-style-type: none"> ● The measurement in Watts indicates the typical power consumption of the device with no external loading. ● The measurement in BTU/h indicates the power consumption of the device when it is fully loaded.
Environmental	
Operating Temperature	0-40 °C
Storage Temperature	-20 - 60 °C
Humidity	0 - 80% RH, Non-Condensing
Physical Properties	
Housing	Metal
Weight	0.33 kg (0.73 lb)
Dimensions (L x W x H)	12.50 x 8.00 x 2.50 cm (4.92 x 3.15 x 0.98 in.)
Carton Lot	20 pcs
Note	For some of rack mount products, please note that the standard physical dimensions of WxDxH are expressed using a LxWxH format.

Diagram

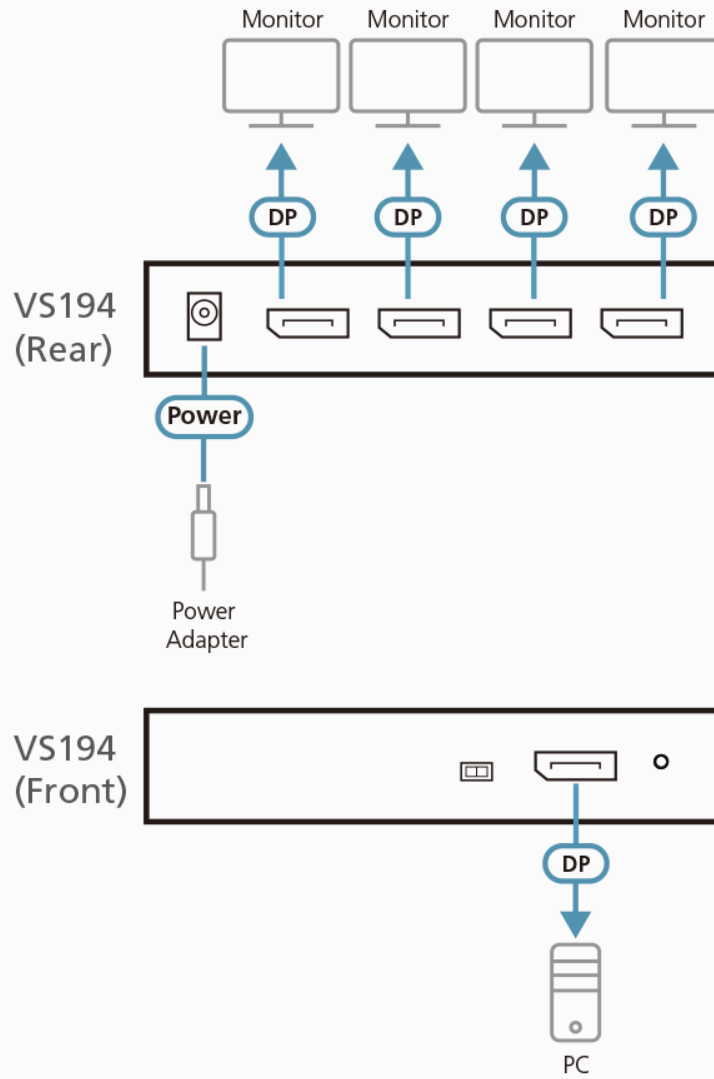

ATEN International Co., Ltd.

3F, No.125, Sec. 2, Datong Rd., Sijhih District., New Taipei City 221, Taiwan
Phone: 886-2-8692-6789 Fax: 886-2-8692-6767
www.aten.com E-mail: marketing@aten.com



© Copyright 2015 ATEN® International Co., Ltd.
ATEN and the ATEN logo are trademarks of ATEN International Co., Ltd.
All rights reserved. All other trademarks are the property of their respective owners.