

## CS52DP

2-Port USB-C DisplayPort Hybrid Cable KVM Switch



# Renovate Your Desktop for the Hybrid Work Challenge



**CS52DP** ▶  
2-Port USB-C DisplayPort Hybrid Cable  
KVM Switch



As an increasingly mobile workforce hot-desks between home and hybrid offices, agility is the key to effective multitasking and remaining engaged in productivity. The compact CS52DP is one of the best choices to meet these hybrid work challenges head on by revamping your workspace with the power of a cable KVM switch and the mobility of USB-C connectivity. Streamline even the most complex workflows by simply pushing the button on the remote port selector to switch between your tasks on one DisplayPort PC and a mobile USB-C device from a DisplayPort and USB console. The DisplayPort-enabled shared screen further assures outstanding 4K audiovisual quality across two computer platforms. Get agile with the CS52DP to jump start your hybrid work productivity and stay ahead of the pack.



4K Visual  
Clarity



Audio  
Enabled



USB Peripheral  
Sharing



Bus  
Powered



Remote  
Port Switching

**Exceptional AV Performance in Vivid 4K**

The CS52DP empowers your desktop workflows with 4K DCI audiovisual enhancement by presenting visual content in outstanding precision.

**Space-Cost Efficient Desktop Setup**

The compact CS52DP enables plug-n-play USB-C connection to a mobile device such as a laptop without going through a docking station, which is a useful, budget-friendly option to expand desktop workspace in a neat and tidy way.



## Contact Us

Get a quote for this product or get in touch with our sales experts

[Get Quote](#)

[Contact Sales](#)

### Smooth Cross-Platform Integration

The CS52DP enables the integration of different computer systems (Windows, Mac, Sun, Linux, Android and iOS) that are accessible over one KVM console.





Camera



Printer



Flash Drive



**Flexible USB Peripheral Sharing**

The console USB ports can be used for plug-n-play connection to compatible USB 2.0 peripheral devices to fulfill data-intensive desktop work requirements.

**Applications**

The CS52DP Cable KVM Switch is perfectly suited to time-critical and multitasking operations in the following scenarios.



Product Comparison

Feature	CS52DP	CS1953
KVM Type	Cable KVM Switch	Desktop KVM Switch
# of computers	2	3
Console interface	USB, DisplayPort	USB, DisplayPort
Computer interface	USB, DisplayPort, USB-C	USB, DisplayPort, USB-C
USB Peripheral	USB 2.0	USB 3.1 Gen 1
Video	4096 x 2160 @ 60 Hz	4096 x 2160 @ 60 Hz
Audio	Speaker, Microphone	Speaker, Microphone
Power Delivery	N/A	✓
Bus-powered	✓	✓
Port Selection	Remote Port Selector	Hotkey, Mouse, Pushbutton, Remote Port Selector
Multi-platform Support	Windows / Mac / Linux / Sun / Android / iOS	Windows / Mac / Linux / Sun / Android / iOS

## Talk to Our Experts

If you prefer to have ATEN contact you, please complete the form and a representative will be in touch with you shortly

- Country \*
▼



- Customer Type \*
▼



### Features

The CS52DP 2-Port USB-C DisplayPort Hybrid Cable KVM Switch is a control unit that allows access to a USB-C device and a DisplayPort computer. With the CS52DP, you can quickly and effortlessly switch between two computers by using a convenient remote port selector pushbutton.

The compact CS52DP also brings in vivid 4K viewing quality to lift up work performance. Further advanced features of the CS52DP include the bus-powered mode and no need to install software or configure device. This plug and play switch is ideal for people who need quick control to multitask between a computer and a USB-C device on a desktop in any environment. Moreover, the compact design allows for an efficient and tidy installation, providing an ideal space-saving solution to keep your desk well-organized.

- One KVM console controls one USB DisplayPort computers and one USB-C device
- Superior video quality – up to 4096 x 2160 @ 60 Hz
- Computer selection via remote port selector
- Supports DisplayPort Alternate Mode (DP Alt Mode) which enables the USB connection to carry DisplayPort signals
- DisplayPort 1.2 and HDCP compliant <sup>1</sup>
- Bus-powered – no external power adapter required
- The console USB ports can be used for USB peripheral sharing <sup>2</sup>
- Multiplatform support – Windows, Mac, Linux, Android, and iOS
- No software required
- Hook design for space-saving and organized workstation
- Supports USB hot-plugging

**Note:**

1. For DisplayPort 1.4 compliant display device, make sure to configure the device setting to be compatible with DisplayPort 1.2 to avoid compatibility issue.
2. The CS52DP may require an external power supply via the USB Micro-B Power Port. For the USB Micro-B cable connecting to the USB Micro-B Power Port, it requires a separate purchase based on the type of the power supply you use.

**Specifications**

Computer Connections	2
Port Selection	Remote Port Selector
Connectors	
Console Ports	1 x DisplayPort Female 2 x USB Type A Female 1 x 3.5mm Audio Jack Female (Green) 1 x 3.5mm Audio Jack Female (Pink)
KVM (Computer) Ports	CPU1: 1 x DisplayPort Male 1 x USB Type A Male 1 x 3.5mm Audio Jack Male (Green) 1 x 3.5mm Audio Jack Male (Pink) CPU2: 1 x USB Type C Male 1 x 3.5mm Audio Jack Male (Green) 1 x 3.5mm Audio Jack Male (Pink)
Power (Optional)	1 x USB Micro Type B Female
LEDs	
KVM Port (On Line /Selected)	2 (White)
Cable Length	
KVM	2 x 1.2 m
Remote Port Selector	1.8 m
Emulation	
Keyboard / Mouse	N/A
Video	Up to 4096 x 2160 @ 60Hz, 2560 x 1440 @ 144Hz
Power Consumption	DC5V:0.74W:8BTU/h  Note: ● The measurement in Watts indicates the typical power consumption of the device with no external loading. ● The measurement in BTU/h indicates the power consumption of the device when it is fully loaded.
Environmental	
Operating Temperature	0 - 50°C
Storage Temperature	-20 - 60°C
Humidity	0-80% RH, Non-condensing
Physical Properties	
Housing	Plastic
Weight	0.30 kg ( 0.66 lb )
Dimensions (L x W x H)	8.34 x 8.42 x 3.04 cm (3.28 x 3.31 x 1.2 in.)
Note	For some of rack mount products, please note that the standard physical dimensions of WxDxH are expressed using a LxWxH format.

Diagram

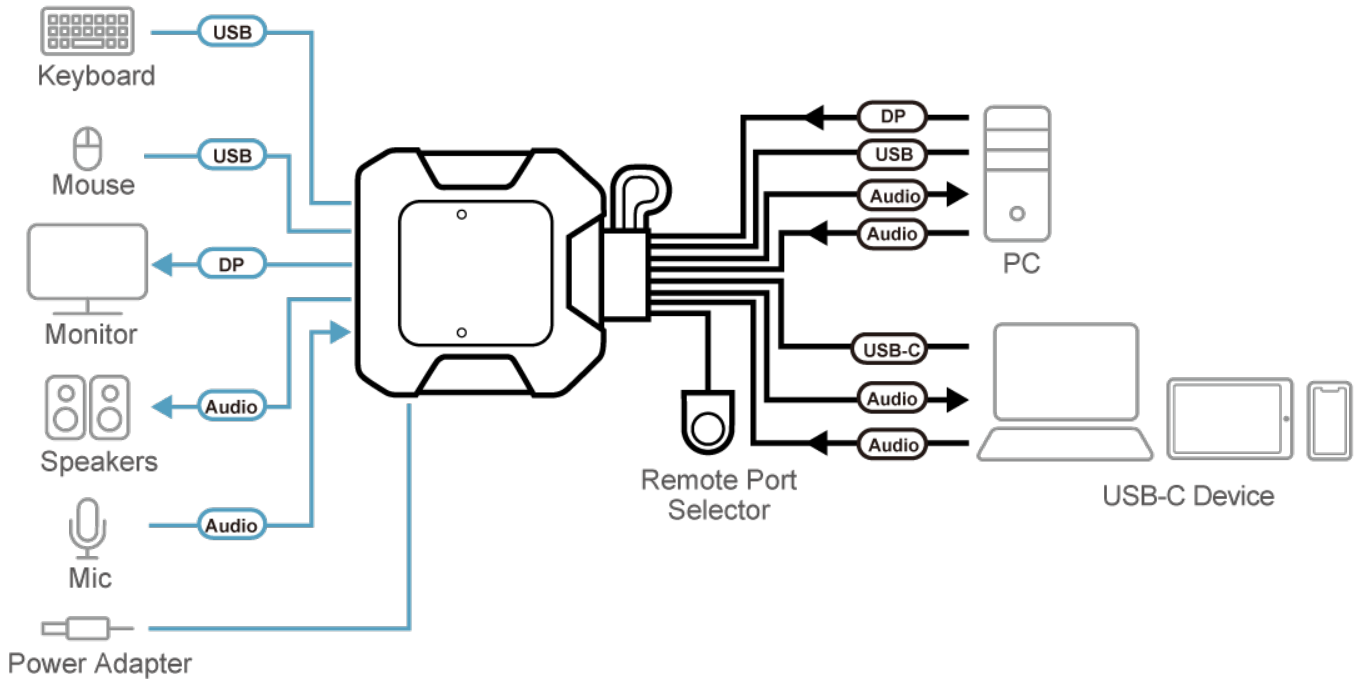

**ATEN International Co., Ltd.**

3F., No.125, Sec. 2, Datong Rd., Sijhih District., New Taipei City 221, Taiwan  
Phone: 886-2-8692-6789 Fax: 886-2-8692-6767  
www.aten.com E-mail: marketing@aten.com



© Copyright 2015 ATEN® International Co., Ltd.  
ATEN and the ATEN logo are trademarks of ATEN International Co., Ltd.  
All rights reserved. All other trademarks are the property of their respective owners.