

VP1421

4 x 2 True 4K Presentation Matrix Switch with Scaling, DSP, and HDBaseT-Lite



Delivering Perfect Presentation Clarity

VP1421

4 x 2 True 4K Presentation Matrix Switch with Scaling, DSP, and HDBaseT-Lite



The VP1421 is a multi-in-one presentation switch that integrates a video matrix, True 4K scaler, HDBaseT extender, audio DSP, and analog-to-digital converter functions into a single compact enclosure, ideal for meeting rooms and educational spaces.

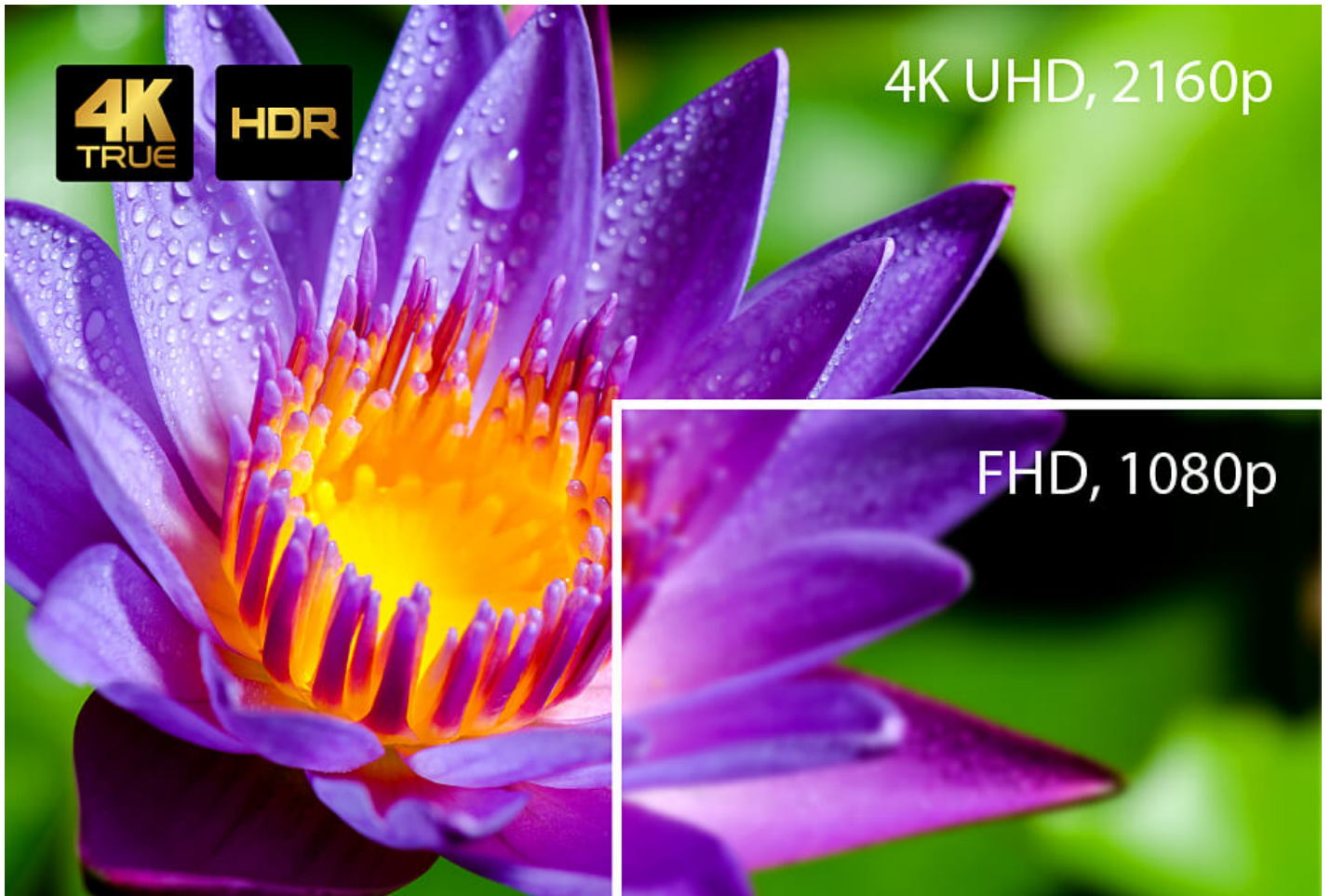

True 4K, HDR Visual Clarity

Supports resolutions up to 4096 x 2160 @ 60Hz (4:4:4) and HDR to deliver vivid content in every presentation.

Smooth AV Switching Scaled to Perfection

Connect up to 4 sources (1 HDBaseT, 2 HDMI, 1 VGA), smoothly switch between them and display contents scaled perfectly to True 4K and 1080p simultaneously.

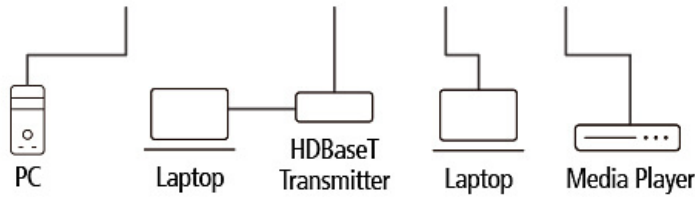
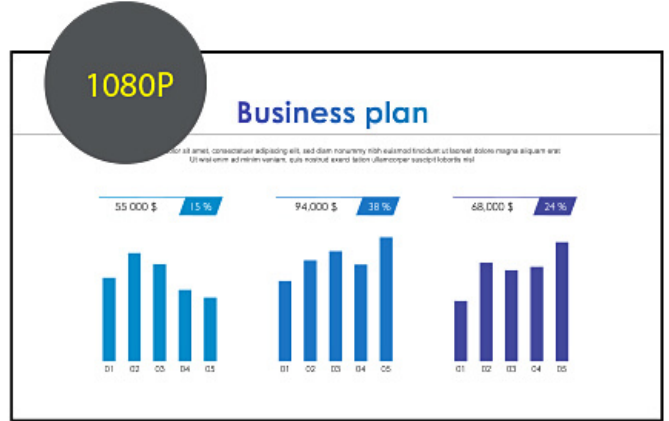

HDBaseT Extended Transmission over One Cable

Simplifies cabling and transmits AV, power, and bi-directional RS-232 and IR control signals up to 140m via Cat 6/6a or ATEN [2L-2910](#) Cat 6 cables (applying both HDBaseT input and output ports).

Contact Us

Get a quote for this product or get in touch with our sales experts

[Get Quote](#)

[_Contact Sales](#)

Built-in Advanced Audio DSP

Supports microphone input with selectable 48V Phantom Power and allows microphone input to be mixed with program audio and embedded into display output while automatically reducing program audio to enhance speech audibility.

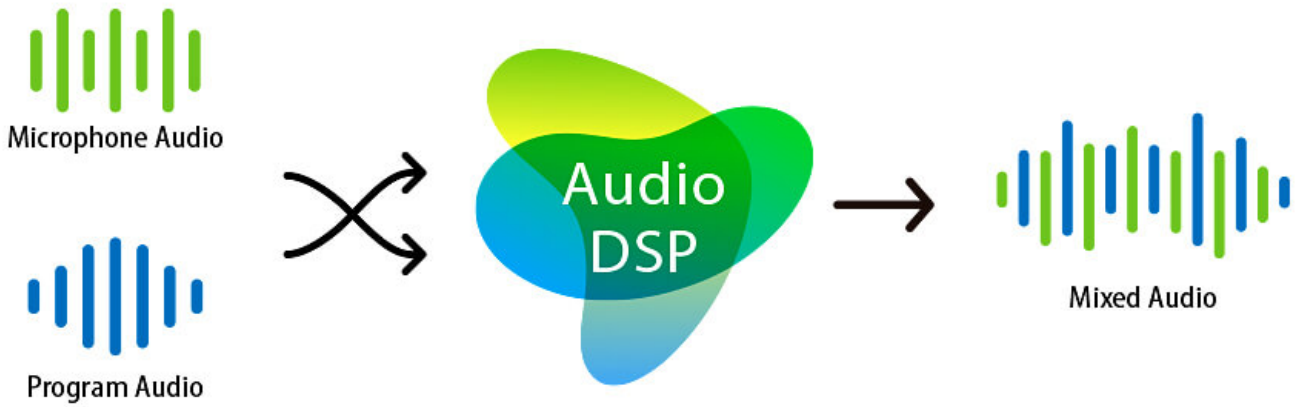

Audio De-embedding

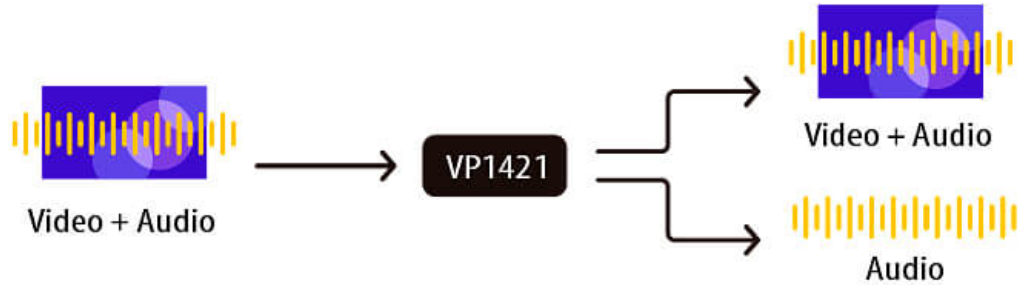

Audio Embedding

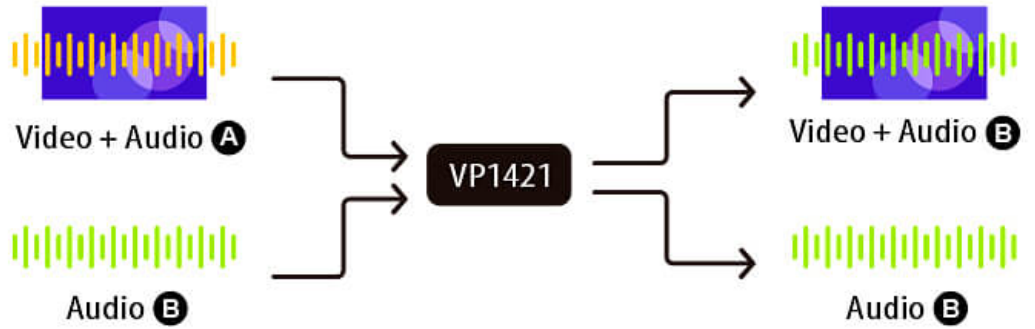

Flexible Audio Embedding/De-Embedding

Supports stereo audio embedding into HDMI output or separation to Audio Line Out and Optical Audio Out. Extract HDMI and HDBaseT audio to different audio outputs as well to ease adaptation to you preferred audio setup.

Versatile Control, Streamlined Operations

Control via front-panel pushbuttons, IR remote, web-based GUI and any control interface via RS-232, Ethernet, and Contact Closure to streamline your operations.

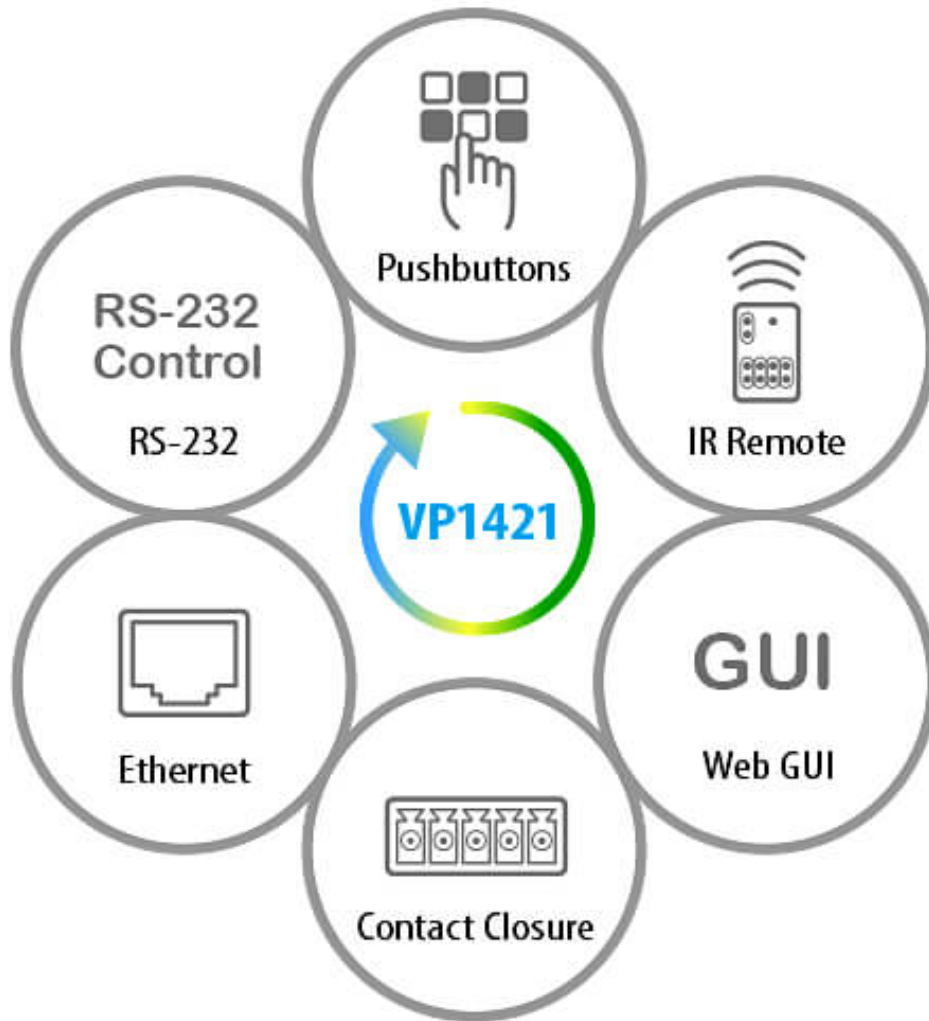

Talk to Our Experts

If you prefer to have ATEN contact you, please complete the form and a representative will be in touch with you shortly

First Name *

Last Name *

- Country *

Company *

Email *

Phone Number *

- Customer Type *

Job Title *



Features

The ATEN VP1421 is a multi-in-one presentation switch that integrates a video matrix switch, 4K scaler *, HDBaseT extender, audio DSP, and analog-to-digital converter functions into one compact device that easily mounts under a table or in a rack. With four analog/digital inputs to one HDBaseT and one HDMI True 4K outputs, it is designed to boost the efficiency and impact of professional presentations.

With streamlined control from front-panel pushbuttons, IR remote controller, RS-232, and web-based GUI via Ethernet, the VP1421 reduces not only system device count, but also lowers operation complexity. It is suitable for all meeting spaces and education environments, such as huddle rooms, classrooms, training rooms, or any other presentation setting, such as in exhibition galleries or hotels.

Note : The VP1421 scaler only supports upscaling 1080p to 4K for display A, and downscaling 4K to 1080p for display B. Other resolution scaling is inapplicable.

• **Analog/Digital AV Matrix Switching**

- Supports multi-format 4 Inputs – 2 HDMI, 1 HDBaseT, and 1 VGA inputs
- 1 HDMI and 1 HDBaseT outputs
- Audio embedding – stereo audio can be embedded into display output or separated to stereo line out and optical audio outputs
- Audio de-embedding – HDMI/HDBaseT audio can be extracted to stereo line out
- Built-in Audio DSP – supports microphone input with selectable 48V Phantom Power and allows microphone input to be mixed with program audio and embedded into display output
- Automatically reduces program audio when a microphone signal is detected
- Auto switching – automatically detects and switches to a new source as soon as it is connected

• **High-definition Video with Optimum Output**

- Superior video quality – True 4K resolutions up to 4096 x 2160@60Hz (4:4:4) (HDMI) / 4096 x 2160@60Hz (4:2:0) (HDBaseT)
- Supports 4K HDR
- Scaler* – supports video upscaling to 4K for display A and downscaling to 1080p for display B
- EDID Expert™ – automatically selects the optimum EDID settings for smooth power-up, high-quality display, and the best video resolution across connected devices
- HDMI (3D, Deep Color, 4K); HDCP 2.2 compliant

Note : The VP1421 scaler only supports upscaling 1080p to 4K for display A, and downscaling 4K to 1080p for display B. Other resolution scaling is inapplicable.

• **Versatile, Streamlined Operation**

- Multiple control options – flexible control via front-panel pushbuttons, IR remote control, RS-232, and web-based GUI through Ethernet
- View and control via [ATEN Video Presentation Control App](#) in a swift and agile way
- Bi-directional RS-232 and IR channel – allows AV device control over HDBaseT connection without additional cabling
- Supports stand-by mode for power saving and fast waking up
- Consumer Electronics Control (CEC) support
- Built-in Contact in and LED out for keypad control using [VPK104](#) Contact Closure Remote Pad

• **Extended Transmission over One Cable**

- Long-distance transmission – transmit digital AV signal, bi-directional RS-232, and IR control signals up to 140m* via Cat 6/6a or ATEN [2L-2910](#) Cat 6 cables
- Power over HDBaseT (POH) – remote powering over existing communication cable with selectable powering device

Note: This is achieved using both the HDBaseT In and the HDBaseT Out ports on the VP1421, each extending the transmission up to 70m.

Specifications

| | |
|-----------------|---|
| Video Input | |
| Interfaces | 2 x HDMI Type A female (Black) 1 x VGA (HDB-15) Female (Blue) 1 x HDBaseT (RJ-45) Female (Silver) with selectable PoH |
| Max. Distance | HDMI: 4K@60Hz (4:4:4) at 5m; 4K@30Hz at 10m; 1080p@60Hz at 15m VGA: 1080p@60Hz at 15m HDBaseT: 4K@30Hz at 35m (Cat 5e/6) / 40m (Cat 6a/ATEN 2L-2910 Cat6); 1080p@60Hz at 60m (Cat 5e/6) / 70m (Cat 6a/ATEN 2L-2910 Cat6) |
| Video Output | |
| Interfaces | 1 x HDMI Type A female (Black) 1 x HDBaseT (RJ-45) Female (Silver) with selectable PoH |
| Max. Distance | HDMI: 4K@60Hz (4:4:4) at 5m; 4K@30Hz at 10m; 1080p@60Hz at 15m HDBaseT: 4K@30Hz at 35m (Cat 5e/6) / 40m (Cat 6a/ATEN 2L-2910 Cat6); 1080p@60Hz at 60m (Cat 5e/6) / 70m (Cat 6a/ATEN 2L-2910 Cat6) |
| Video | |
| Max. Resolution | HDMI: Up to 4096 x 2160 / 3840 x 2160 @ 60Hz (4:4:4) VGA: Up to 1080p@60Hz HDBaseT: Up to 4096 x 2160 / 3840 x 2160 @ 60Hz (4:2:0) ; Up to 4096 x 2160 / 3840 x 2160 @ 30Hz (4:4:4) |

| | |
|-----------------------------|---|
| Compliance | HDMI (3D, Deep Color, 4K); 4K HDR HDCP 2.2 Compatible; Consumer Electronics Control (CEC) |
| Audio | |
| Input | Stereo Audio (HDMI/HDBT): 1 x mini stereo Jack female (Green) Stereo Audio (VGA): 1 x mini stereo Jack female (Green) Microphone: 1 x 6.3mm Jack connector (with selectable phantom power) |
| Output | Line Out (Unbalanced): 1 x Captive Screw Connector, 3-pole Optical Audio: 1 x Toslink (Black) |
| Control | |
| RS-232 | 1 x Captive Screw Connector, 3-pole |
| IR | 1 x Mini Stereo Jack Female (Black) |
| Ethernet | 1 x RJ-45 Female (Silver) |
| Contact In | 1 x Captive Screw Connector, 5-pole |
| LED Out | 1 x Captive Screw Connector, 5-pole LED out power: +5 VDC, 0.2 A |
| IR Channel | HDBaseT In : 1 x Mini Stereo Jack Female (Black) HDBaseT Out : 1 x Mini Stereo Jack Female (Black) |
| RS-232 Channel | HDBaseT In : 1 x Captive Screw Connector, 3-pole HDBaseT Out : 1 x Captive Screw Connector, 3-pole |
| Switches | |
| Power | 1 x Pushbutton (LED: Green / Orange) 1 x Slide Switch (+48V Phantom Power) 1 x Slide Switch (PoH) |
| Video Input Port Selection | 4 x Pushbutton (LED: Green) |
| Video Output Port Selection | 2 x Pushbutton (LED: Orange) |
| Selection | Mic: 1 x Knob Volume: 1 x Knob Mode / Unlock: 1 x Pushbutton |
| EDID Settings | EDID Mode: ATEN Default / Display A / Remix |
| Connectors | |
| Power | 1 x DC Jack (Black) |
| Power Consumption | DC12V:14.93W:110BTU/h Note: ● The measurement in Watts indicates the typical power consumption of the device with no external loading. ● The measurement in BTU/h indicates the power consumption of the device when it is fully loaded. |
| Environmental | |
| Operating Temperature | 0-40°C |
| Storage Temperature | -20 - 60°C |
| Humidity | 0 - 80% RH, Non-Condensing |
| Physical Properties | |
| Housing | Metal |
| Weight | 1.16 kg (2.56 lb) |
| Dimensions (L x W x H) | 20.00 x 17.01 x 4.40 cm (7.87 x 6.7 x 1.73 in.) |
| Carton Lot | 3 pcs |
| Note | For some of rack mount products, please note that the standard physical dimensions of WxDxH are expressed using a LxWxH format. |

Diagram

► Diagram

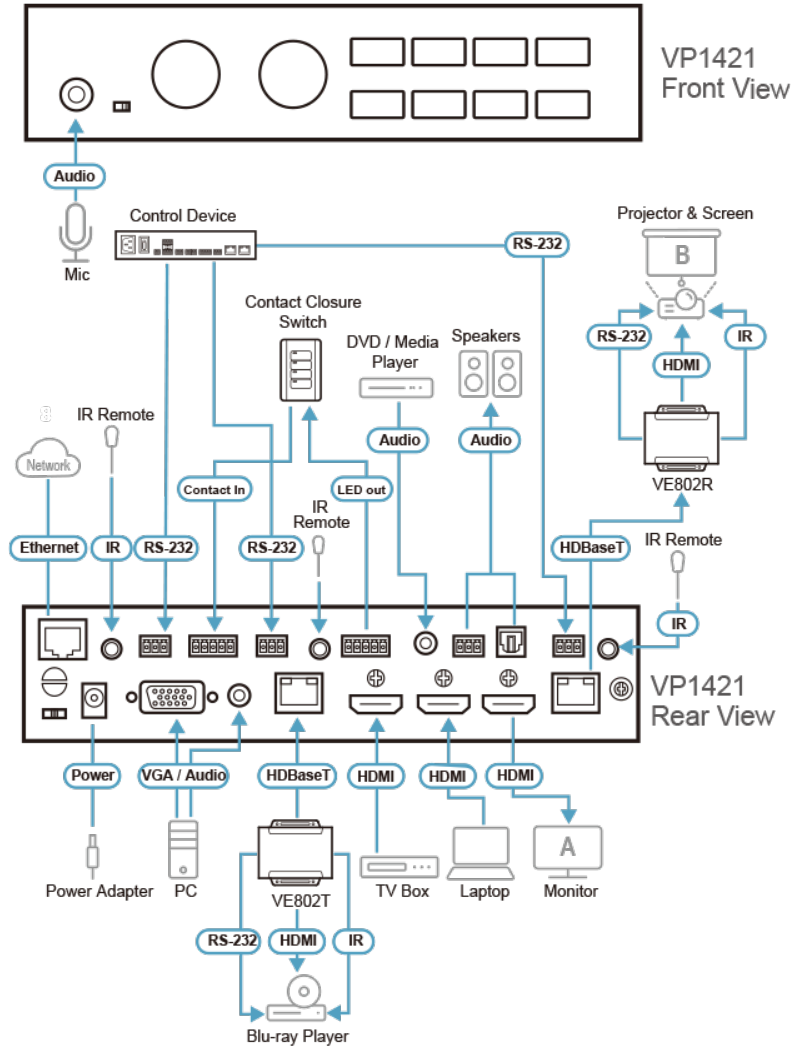

ATEN International Co., Ltd.

3F., No.125, Sec. 2, Datong Rd., Sijhih District., New Taipei City 221, Taiwan
 Phone: 886-2-8692-6789 Fax: 886-2-8692-6767
 www.aten.com E-mail: marketing@aten.com



© Copyright 2015 ATEN® International Co., Ltd.
 ATEN and the ATEN logo are trademarks of ATEN International Co., Ltd.
 All rights reserved. All other trademarks are the property of their respective owners.