

VP2420

4 x 2 True 4K HDMI Presentation Switch with Multi View



Complete Clarity, Cooperative Success

Matrix Output with True 4K Quad-View for Ultimate Efficiency



VP2420

4 x 2 True 4K HDMI Presentation Matrix Switch with Multi View



Experience seamless collaboration and efficient decision-making with the ATEN VP2420 Presentation Switch, 4x2 True 4K HDMI Presentation Switch with Multi View. It delivers a stunning viewing experience across mixed resolution displays and ensures smooth switching between two screens with multiple sources. With multi-view functionality, it enables comprehensive data presentation, allowing participants to workshop ideas and compare information on a single screen. Its smart layout adjustment maintains a seamless flow as sources connect or disconnect, keeping meetings smooth and uninterrupted. The VP2420 supports versatile audio setups with options for audio embedding or separate extraction. Whether used standalone or integrated with control systems, it offers easy source control and future scalability with up to 4 presentation switches cascaded, making every presentation captivating, smooth, and efficient.



True 4K



Advanced Scaler

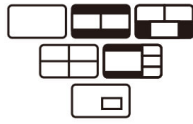

6 Multi-View Layouts

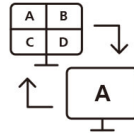

Matrix Output



Audio Embedding & De-embedding



Control Methods

Multi-View Display with Automatic Layout Adaptation

Elevate your team collaboration and discussion with the VP2420, capable of displaying up to four video content sources on a single screen. This versatile setup facilitates side-by-side data comparison and the exchange of ideas among multiple participants, enhancing effective teamwork and decision-making. New video sources can be integrated into the existing layout anytime for a smooth and dynamic display experience.

Visual Excellence with True 4K Clarity and Advanced Scaler

Experience stunning True 4K/60 resolution with the VP2420, delivering exquisite details and intricate visuals for an unparalleled viewing experience. Its advanced scaler seamlessly handles most-common input resolution up to True 4K or downscales to 1080p, offering a smooth and simultaneous display of mixed-resolution sources.



Unlock Perspectives with Matrix Output on 2 Displays

Beyond merely splitting sources across two screens, the VP2420 features two independent displays: one capable of handling up to four sources at once, and the other highlighting the content for discussion. This setup provides a comprehensive view, ensuring focused and efficient discussions that accelerate the decision-making process.



Six Preset Rapid Multi-View Layouts

The VP2420 allows video content to be flexibly presented in six different multi-view layouts. It offers options such as quad, triple, picture-in-picture (PiP), picture-by-picture (PbP), and full screen, all of which can switch seamlessly within one second. This provides a dynamic and efficient display, meeting any presentation need.

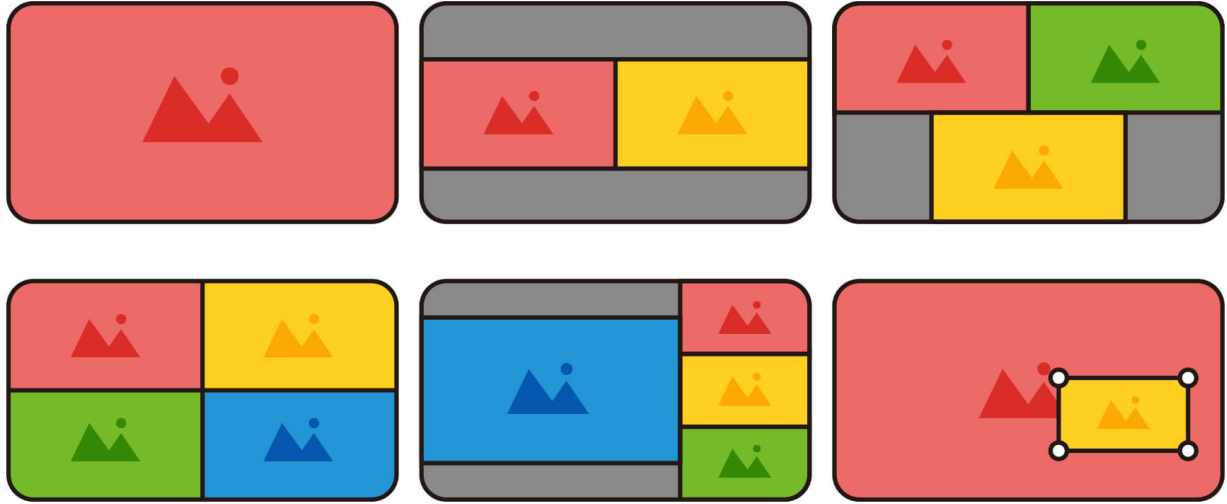

Audio Flexibility with Embedding and De-embedding Function

The VP2420 enhances presentations with flexible audio options, allowing for separate audio track integration into video content (embedding) or extraction (de-embedding) of audio from the video signal for independent processing through amplifiers or speakers.



Managing presentations with the VP2420 is effortless, offering a wide range of control options such as front panel, push buttons, IR controllers, web GUI, [mobile app](#), RS-232, and Ethernet. Integration with control systems further enhances control, providing a comprehensive and streamlined presentation experience.

The image illustrates the ATEN VP2420's capabilities in a meeting room. The main display shows a multi-panel presentation with charts and graphs. In the foreground, a laptop displays the 'Video Control' interface, which includes a 4x4 grid of source buttons (1-16), a 'Layout' dropdown set to 'Quad-1', and a 'Source' dropdown set to 'NAME'. A 'Display A' and 'Display B' section shows a single source (1) selected. Below the laptop, six icons represent control methods: a hand pointing to a button (Push Button), a remote control (IR Remote), a gear with 'GUI' (Web GUI), a computer monitor with a gear (RS-232 Control), a network card (Ethernet), and a smartphone (Mobile App).

Perfect for Meeting Spaces and Classrooms

The VP2420 is perfectly suited for use in huddle rooms, medium-sized meeting rooms, and classrooms to deliver collaborative presentations or training courses through a dynamic viewing experience.

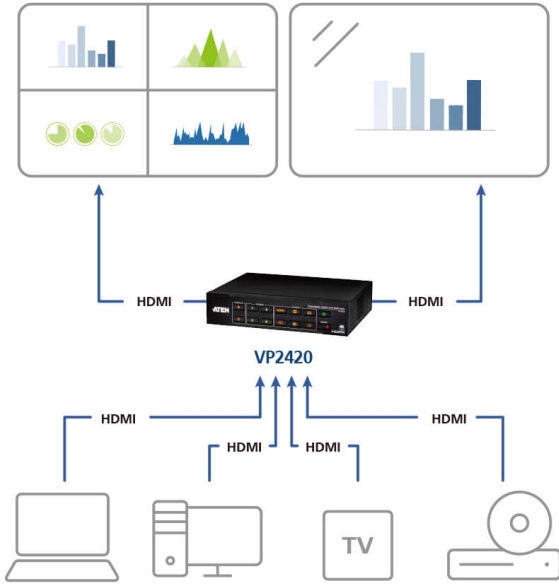

Product Comparison



HDMI™
HIGH-DEFINITION MULTIMEDIA INTERFACE



Multi-View
Layouts

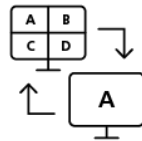

Matrix Output



Web GUI

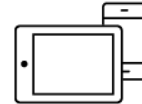

Mobile App

Features

The VP2420 is a presentation switch featuring 4 HDMI inputs and 2 HDMI outputs and is capable of displaying video content in full screen, PIP, PbP, triple/quad multi-view. With display mode (Matrix/Mirror) and layout mode (Auto/Manual) selectable and its capability of seamless switching* among multiple sources, the VP2420 delivers a dynamic viewing experience in any conference settings. In addition to the support for 4096 x 2160/3840 x 2160 @ 60Hz (4:4:4), a True 4K scaler is also built in the device to ensure crisp and detailed visual quality. Thanks to the audio embedding and de-embedding functionalities, users can adapt suitable audio/video combinations based on various environments.

Designed with flexibility in mind, the VP2420 offers versatile control options including front-panel pushbuttons, RS-232, IR, Telnet, Web GUI, and [ATEN Video Presentation Control mobile app](#), allowing multimedia signals to be easily managed and incorporated into a collaborative event. The VP2420 can be cascaded up to 2 levels by connecting additional 4 VP2420 units to reach the maximum of 16 HDMI video sources being simultaneously displayed on a single screen. Rack-mounting is supported for flexible installation. With a set of features coming in a compact, all-metal casing, which enhances durability, the VP2420 serves as a perfect solution for smooth presentation flow and seamless transition in any education or commercial conferencing applications.

*Note: The function is only available on Display A and applicable to single port switching. Multiview layout switching is inapplicable.

• Seamless AV Matrix Switching

- Supports 4 x HDMI inputs and 2 x HDMI outputs
- Supports Multi-view (full screen, PIP, PbP, triple/quad multi-view), Matrix/Mirror display modes, and Auto/Manual layout modes
- Supports audio embedding and de-embedding
- Seamless switching* at near-zero-second speed
- Auto switching – automatically detects and switches to the latest active source connection

• Visually Stunning True 4K Outputs

- Supports up to 4096 x 2160/3840 x 2160 @ 60Hz (4:4:4) and 4K HDR
- Built-in True 4K scaler – supports video upscaling to True 4K
- EDID Expert™ – automatically selects the optimum EDID settings for smooth power-up, high-quality display, and the best video resolution across connected devices
- HDMI (Deep Color, 4K); HDCP 2.2 compliant

• The Ultimate Flexibility in Streamlining Operation

- Multiple control options – front-panel pushbuttons, RS-232, IR, Telnet, Web GUI, and [ATEN Video Presentation Control mobile app](#).
- Consumer Electronics Control (CEC)
- Can be cascaded up to 2 levels by connecting additional 4 VP2420 units to reach the maximum of 16 video sources being simultaneously displayed
- Long distance transmission – up to 5m via a High Speed HDMI cable
- Supports stand-by mode for power saving and fast waking up
- Rack-mountable
- All-metal casing enhances durability

* Note: The function is only available on Display A and applicable to single port switching. Multiview layout switching is inapplicable.

Specifications

Video Input	
Interfaces	4 x HDMI Type A female (Black)
Max. Distance	HDMI: 4K@60Hz (4:4:4) at 5m; 4K@30Hz at 10m; 1080p@60Hz at 15m
Video Output	
Interfaces	2 x HDMI Type A female (Black)
Max. Distance	HDMI: 4K@60Hz (4:4:4) at 5m; 4K@30Hz at 10m; 1080p@60Hz at 15m
Video	
Max. Resolution	HDMI: Up to 4096 x 2160 / 3840 x 2160 @ 60Hz (4:4:4)
Compliance	HDMI (Deep Color, 4K); 4K HDR HDCP 2.2 Compatible; Consumer Electronics Control (CEC)
Audio	
Input	Stereo Audio (HDMI): 1 x mini stereo Jack female (Green)
Output	Line Out (Unbalanced): 1 x Captive Screw Connector, 3-pole (PCM 2CH) Digital Audio: 1 x Coaxial (LPCM 2CH, Dolby Digital, DTS)
Control	
RS-232	1x DB-9 Female (Black); VP device control & configuration
IR	1 x Mini Stereo Jack Female (Black)
Ethernet	1 x RJ-45 Female (Silver)

Switches	
Power	1 x Pushbutton (LED: Green / Orange)
Video Input Port Selection	4 x Pushbutton (LED: Green)
Video Output Port Selection	2 x Pushbutton (LED: Orange)
Multi-View Mode	Layout: 6 x Pushbutton (Full Screen, PiP, PbP, Triple/ Quad multi-view)
Selection	Mute: 1 x Pushbutton Mode / Unlock: 1 x Pushbutton
EDID Settings	EDID Mode: ATEN Default / Display A / Remix
Connectors	
Power	1 x DC Jack (Black)
Power Consumption	DC12V:17.1W:80BTU/h Note: <ul style="list-style-type: none"> ● The measurement in Watts indicates the typical power consumption of the device with no external loading. ● The measurement in BTU/h indicates the power consumption of the device when it is fully loaded.
Environmental	
Operating Temperature	0-40°C
Storage Temperature	-20 - 60°C
Humidity	0 - 80% RH, Non-Condensing
Physical Properties	
Housing	Metal
Weight	1.05 kg (2.31 lb)
Dimensions (L x W x H)	20.00 x 16.05 x 4.40 cm (7.87 x 6.32 x 1.73 in.)
Carton Lot	3 pcs
Note	For some of rack mount products, please note that the standard physical dimensions of WxDxH are expressed using a LxWxH format.

Diagram

► Connection Diagram

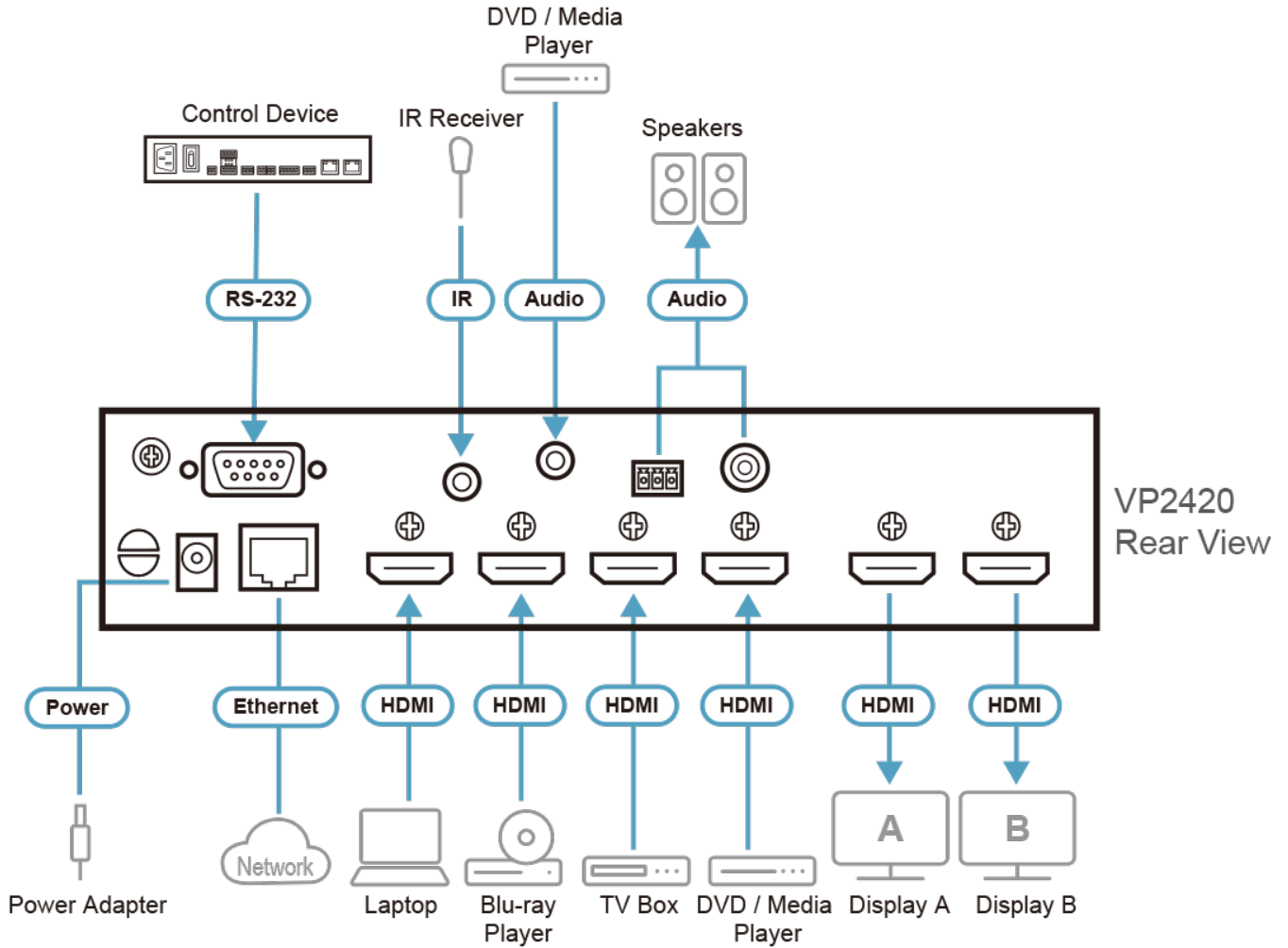

ATEN International Co., Ltd.

3F., No.125, Sec. 2, Datong Rd., Sijhih District., New Taipei City 221, Taiwan
 Phone: 886-2-8692-6789 Fax: 886-2-8692-6767
 www.aten.com E-mail: marketing@aten.com



© Copyright 2015 ATEN® International Co., Ltd.
 ATEN and the ATEN logo are trademarks of ATEN International Co., Ltd.
 All rights reserved. All other trademarks are the property of their respective owners.